

RAVEN

KSZ 144

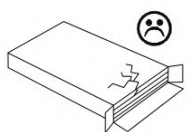
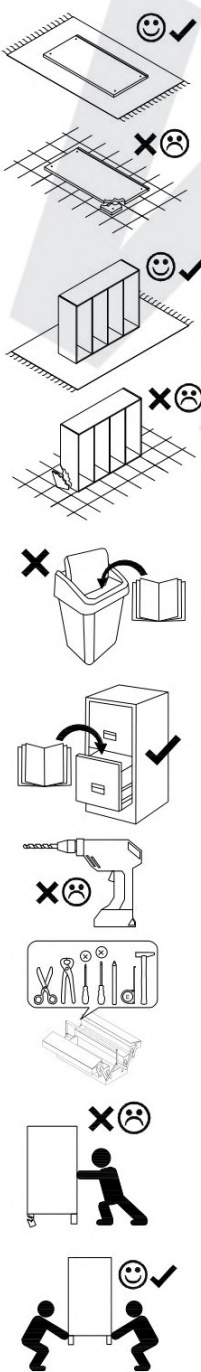
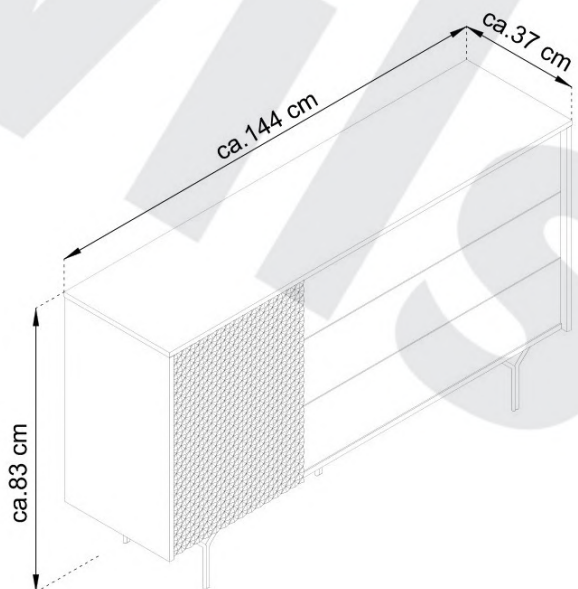

ca. 2 H

- (D) Montageanleitung
- (FR) Notice de montage
- (NL) Handleiding voor de montage
- (CZ) Montážní návod
- (HU) Szerelési útmutató
- (TR) Montaj talimatı

- (GB) Assembly Instructions
- (IT) Istruzioni di montaggio
- (PL) Instrukcja montaży
- (SK) Návod na montáž
- (RO) Instrucțiuni de montaj
- (RU) Инструкции по монтажу

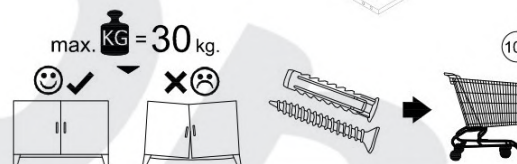

A	8x32	B	PPW45P L300	S	L-614mm
x38	x24	x3kpl	x1		
C		NS	3,5x13	ND	3,5x16
x24	x3	x6	x37	KG	x1
W+H2	TA	W	4x60	Y	N
x2	x1	x3	x5	x28	
X	NE	Z	ZC	ZZ	
x10	x20	x14	x4	x4	

1	1440	375	16	x1	2 / 3
2	1407	354	16	x1	2 / 3
3L	630	375	16	x1	3 / 3
3R	630	375	16	x1	3 / 3
4	614	334	16	x1	3 / 3
5	454	320	16	x1	2 / 3
6	1407	120	16	x1	2 / 3
7	622	465	18	x1	3 / 3
8	930	200	16	x3	2 / 3
9	888	305	2.5	x3	2 / 3
10L	300	150	16	x3	3 / 3
10R	300	150	16	x3	3 / 3
11	877	130	16	x3	2 / 3
12	469	625	2.5	x2	3 / 3
13	481	625	2.5	x1	3 / 3

17.02.2023

! Uwaga • Upozornění • Achtung • Attention • Caution • Figyelem !
! Attenzione • Opgelet • Внимание • Atenție • Upozornenie • Dikkat !

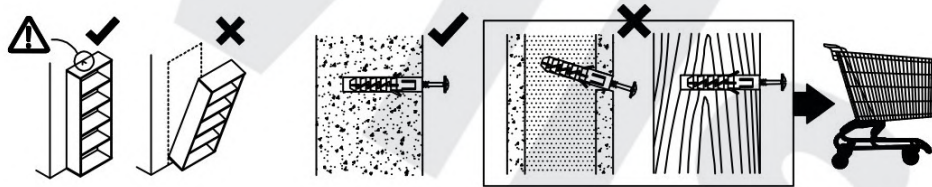
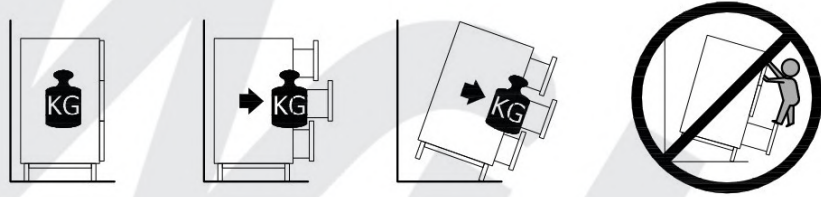

! Uwaga • Upozornění • Achtung • Attention • Caution • Figyelem !
! Attenzione • Opgelet • Внимание • Atenție • Upozornenie • Dikkat !

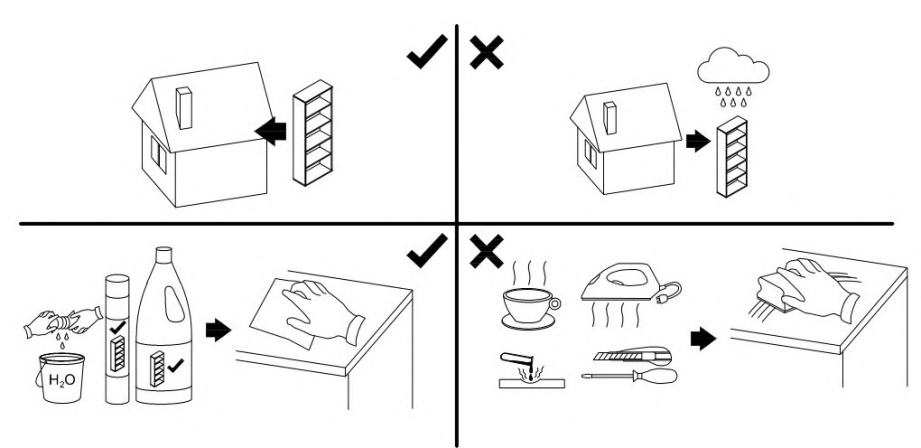

PL	Mocowanie do ściany jest jednocześnie zabezpieczeniem przed przewróceniem - koniecznie zamontować! Do niektórych rodzajów ścian koniecznie zastosować specjalne kołki mocujące.
CZ	Montáž na stěnu slouží jako ochrana proti převrnutí - bezpodmínečně umístěte! U některých typů stěn může být zapotřebí speciální hmoždinka!
DE	Wandbefestigung dient als Kippschutz - unbedingt anbringen! bei einigen Wandtypen kann ein Spezialdübel erforderlich sein!
GB	The wall fastening serves to prevent tipping - be absolutely sure to mount it! For certain wall types, a special wall plug may be necessary!
FR	La fixation murale sert de protection contre le basculement - à installer impérativement! Pour certains types de murs il faut des chevilles spéciales!
NL	Bevestiging aan de muur dient als kantelbescherming - zeker en vast bevestigen! Bij enkele muurtypen is een speciale plug misschien vereist!
IT	Il fissaggio alla parete serve da protezione anti-ribaltamento-attaccarla assolutamente! Per alcune strutture di parete può essere necessario un tassello speciale!
HU	A terméket a falhoz kel rögzíteni, különben az felborulhat! Egyes faltípusoknál speciális tiplít kell használni!
RU	Обязательно установите крепление на стене во избежание опрокидывания! Для некоторых типов стен может потребо- ваться специальный дюбель!
RO	Sistemul de fixare la perete servește ca protecție la răsturnare - de montat obligatoriu! Pentru unele tipuri de pereți este posibil să fie necesar un diblu special!
SK	Upevnenie na stenu slúži ako ochrana proti prevráteniu - bezpodmínečne použite! Pre niektoré druhy stein môže byť potrebná špeciálna hmoždinka!
TR	Duvardaki sabitleme, devrilmeye karşı bir emniyet tedbiridir ve mutlaka monte edilmelidir! Bazı duvar tiplerinde bunun için özel bir dübel gerekli olabilir!

PL	Czyszczenie należy wykonać wyłącznie za pomocą ściereczki lub lekko nawilżonego ręcznika. Nie stosować środków czyszczących do szorowania.
CZ	Čištění je nutné vykonávat výhradně pomocí utěrky nebo lehce navlženého ručníku. Nepoužívejte čističí prostředky obsahující abrazivní částice.
DE	Bitte nur mit einem Staubtuch oder leicht feuchtem Lappen reinigen. Keine scheuernden Putzmittel verwenden.
GB	Please only clean with a duster or damp cloth. Do not use any abrasive cleaners.
FR	Le nettoyage se fait uniquement à l'aide d'un torchon ou d'une serviette légèrement mouillée.
NL	Reinig alleen met een stofdoek of een lichtjes vochtige doek. Gebruik geen schurende poetsmiddelen.
IT	Pulire esclusivamente con un panno o un asciugamano umido.
HU	A tisztítás kizárólag töröruha vagy enyhén nedvesített törölköző segítségével végezhető. Súroló hatású tisztítószerket nem szabad használni.
RU	Очищайте от пыли тряпкой или слегка влажной ветошью. Не допускается применение чистящих средств, не предназначенных для ухода за мебелью.
RO	Curățarea trebuie efectuată numai cu o cârpă sau cu un prosop ușor umezit. Nu utilizați agenți de curățare abrazivi.
SK	Čistenie je nutné vykonávať výhradne pomocou utierky alebo ľahko zvlhnutým ručníkom. Nepoužívajte čistiaci prostriedky obsahujúci abrazívni častice.
TR	Lütfen sadece bir toz bezilye veya hafif nemli yumuşak bir bezle siliniz. Aşındırıcı temizlik malzemeleri kullanmayınız.

NS			1:1
----	--	--	-----

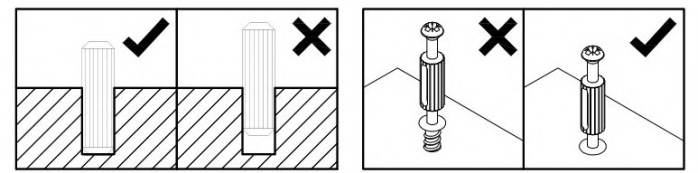
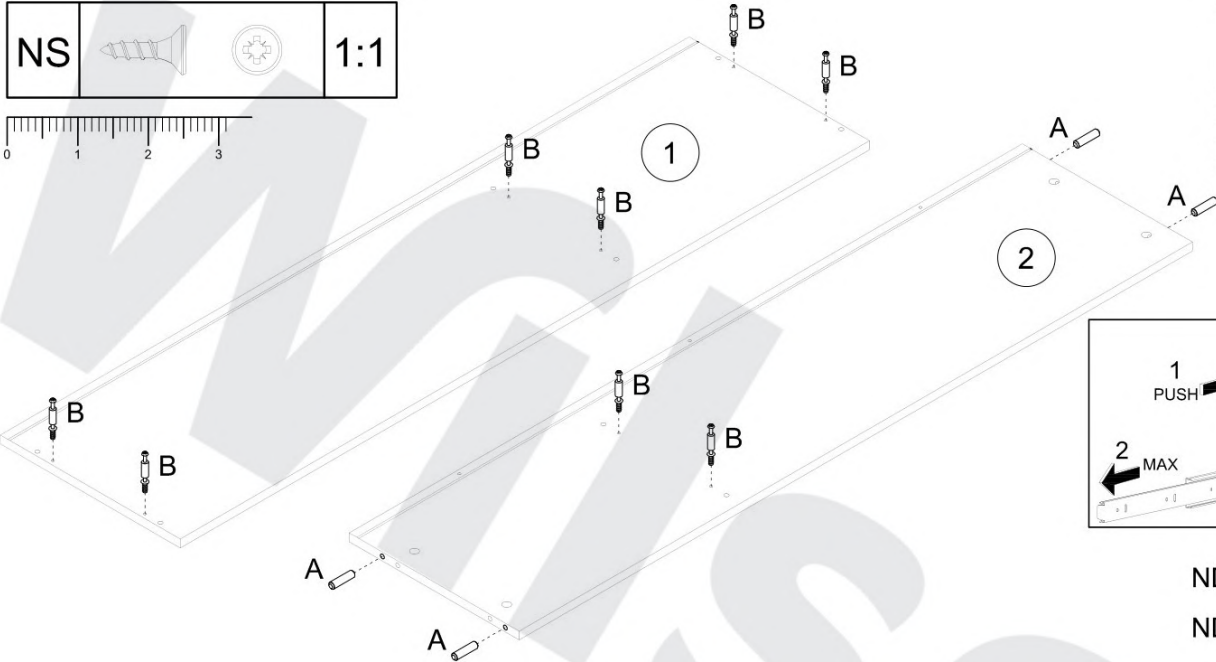

1

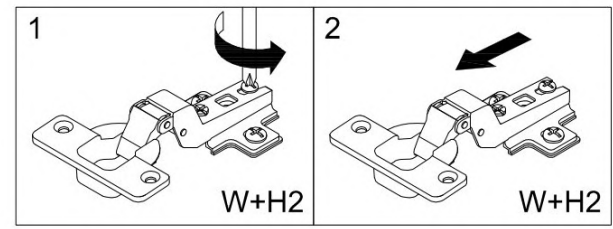
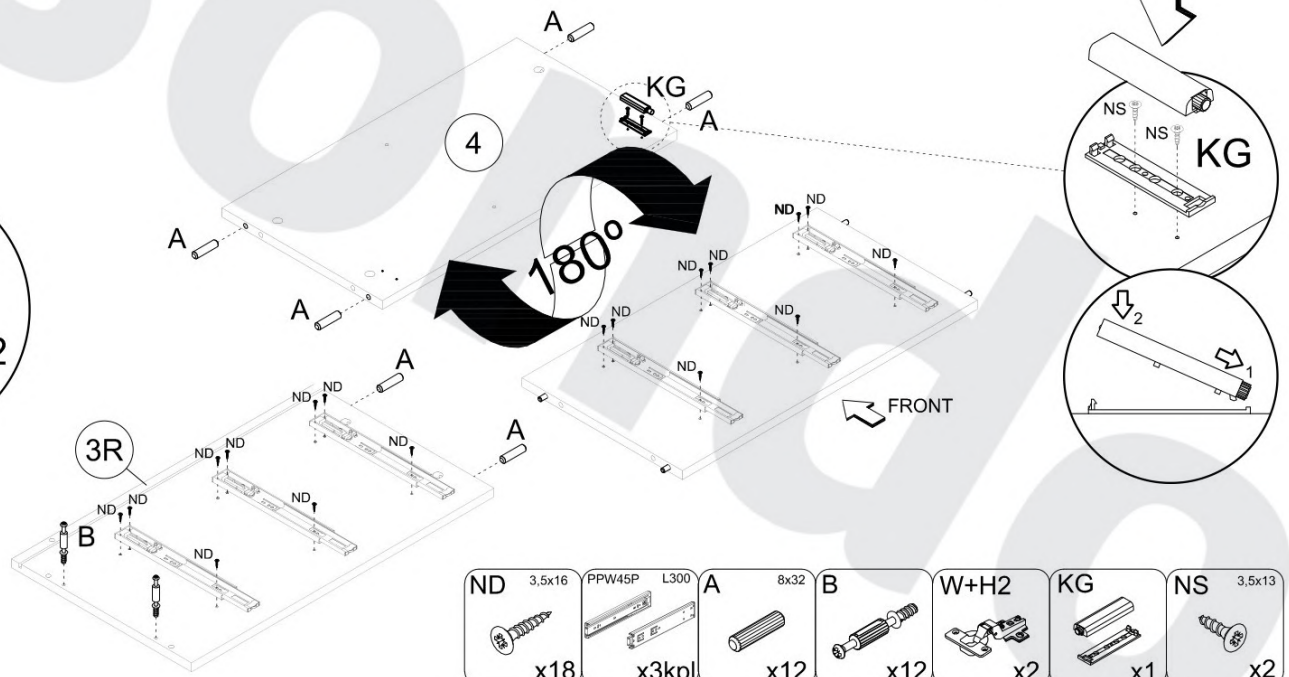
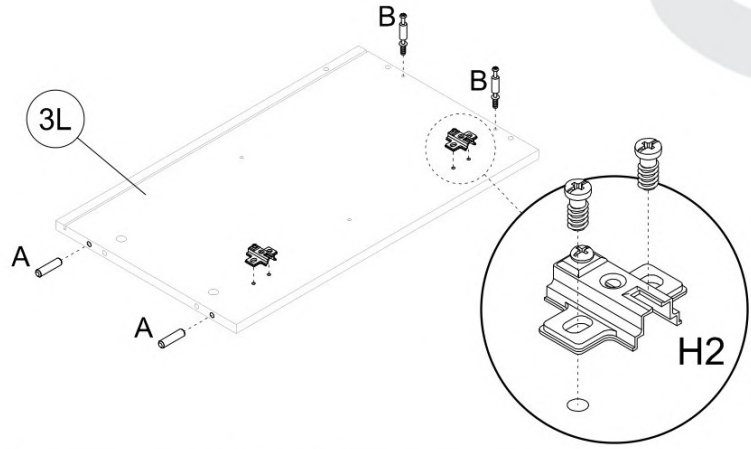
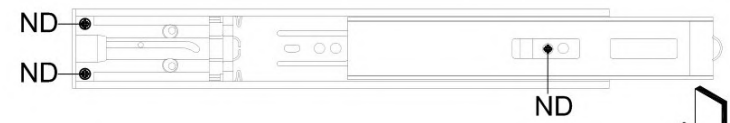
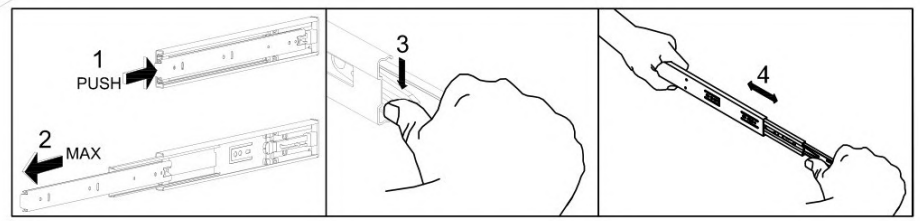

ND	3,5x16	PPW45P	L300	A	8x32	B	W+H2	KG	NS	3,5x13
x18		x3kpl		x12	x12	x2	x1	x2		

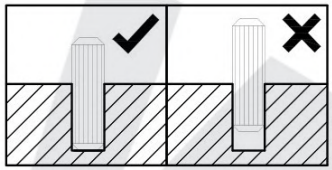

2

A

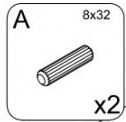
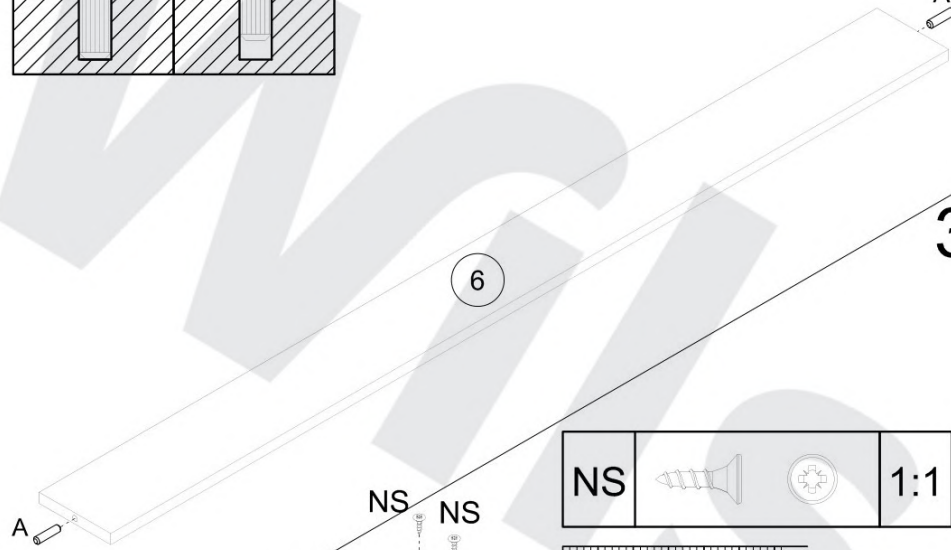

7

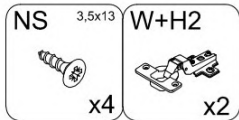

4

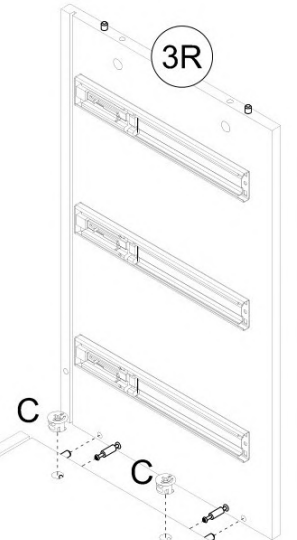
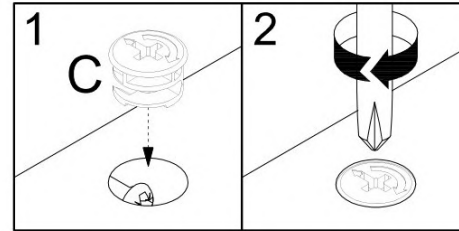

2

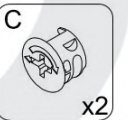
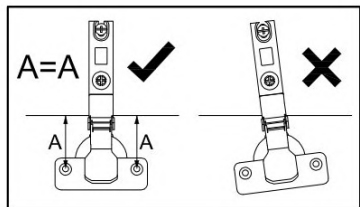

5

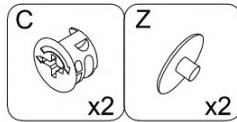
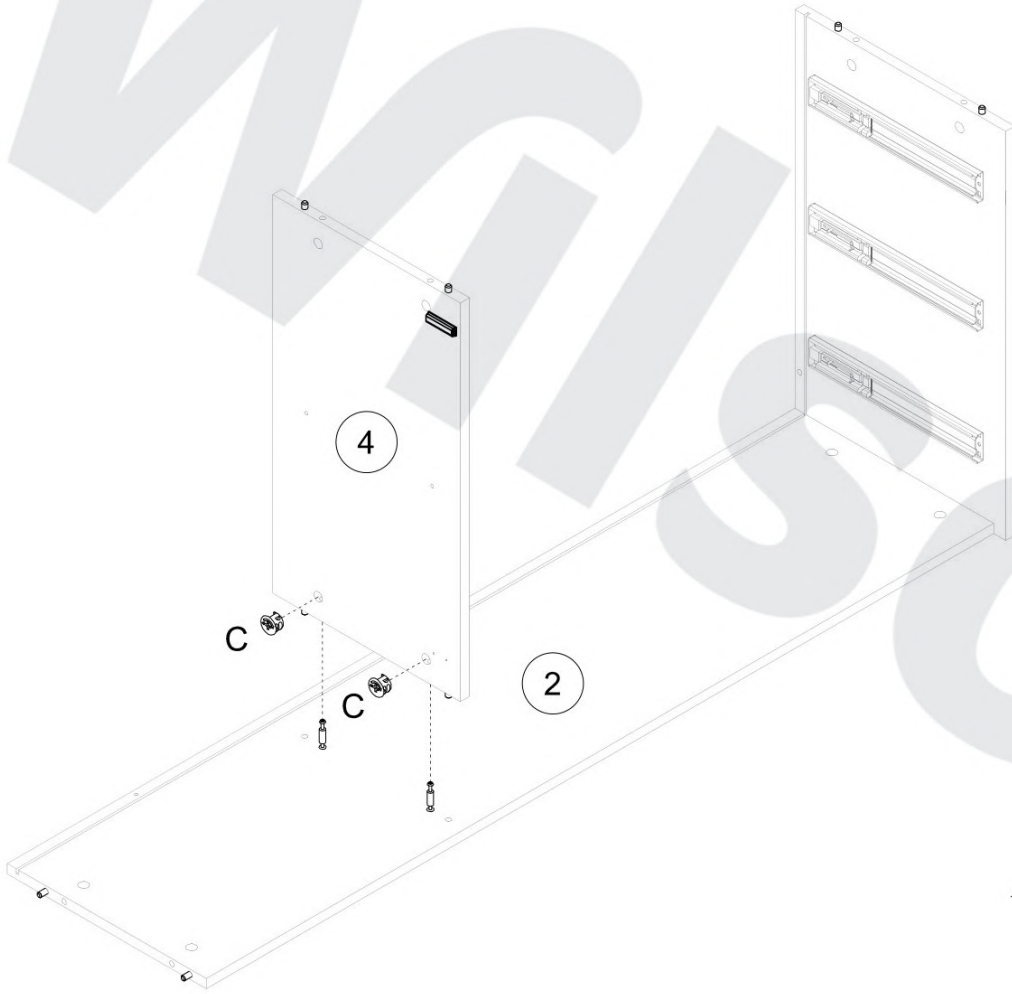

6

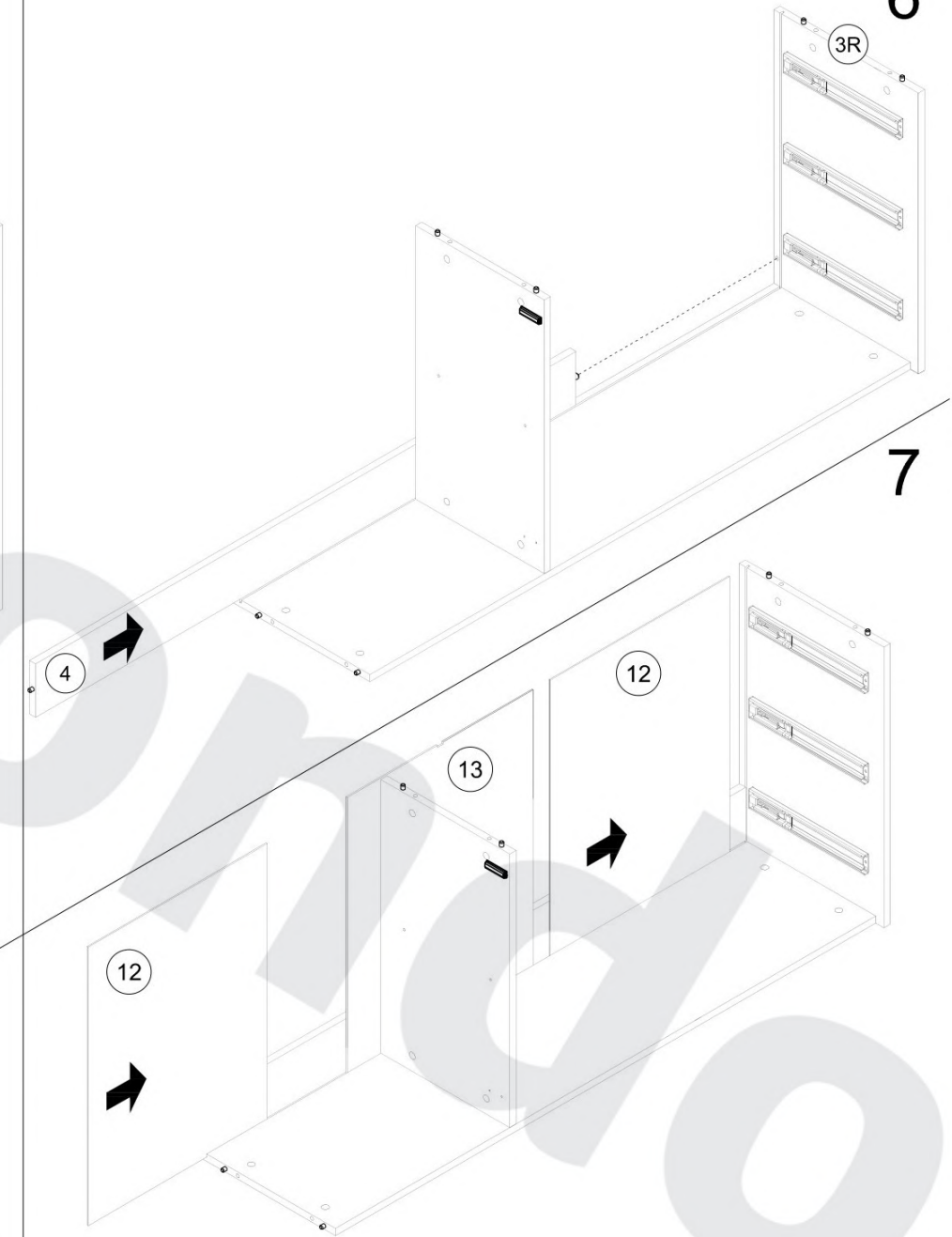

8

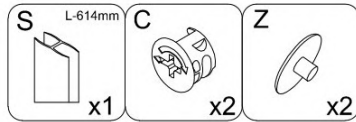
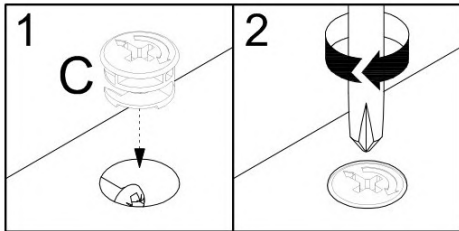
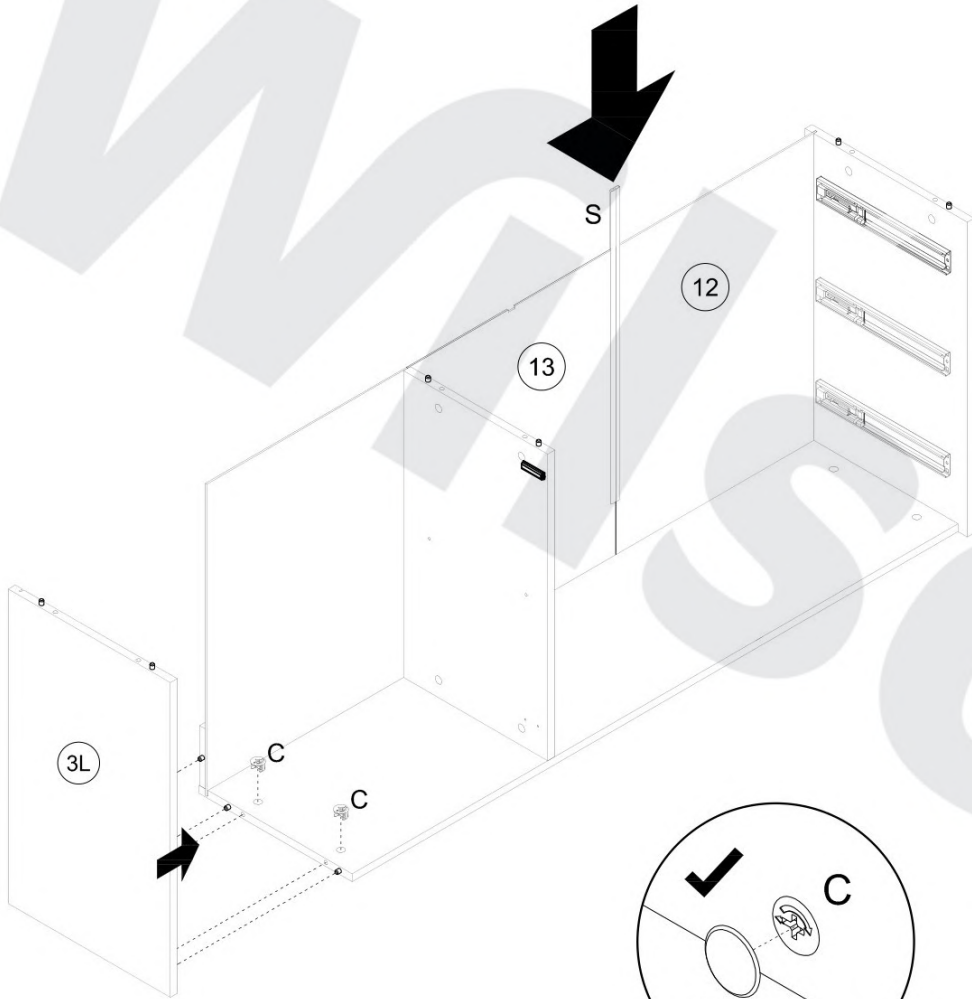

9

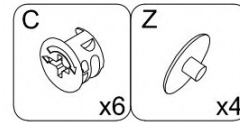
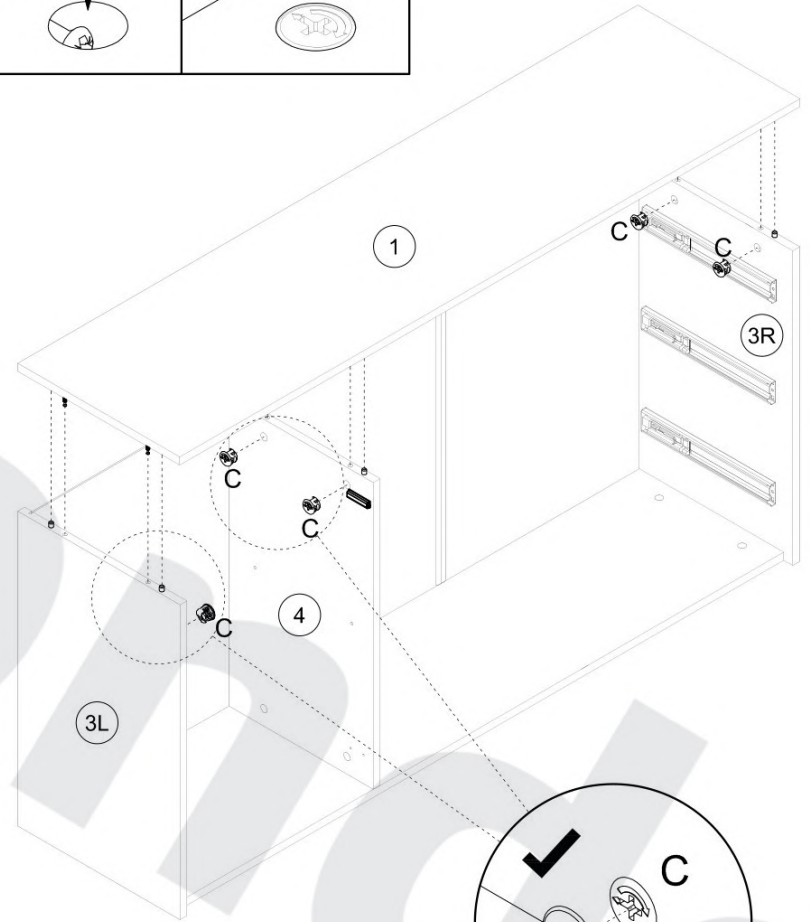
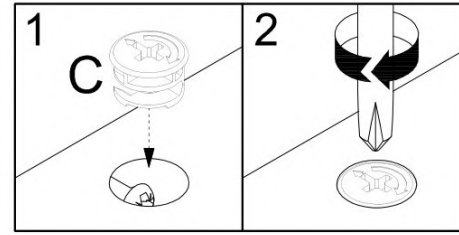

10

11

W	1:1		
N	1:1		
NE	1:1		

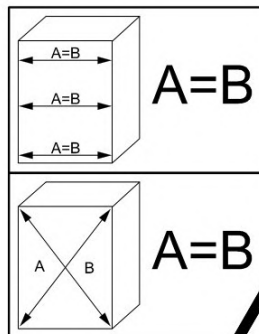

x3

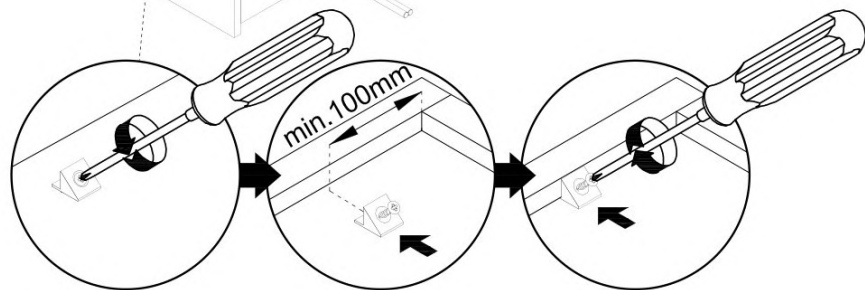
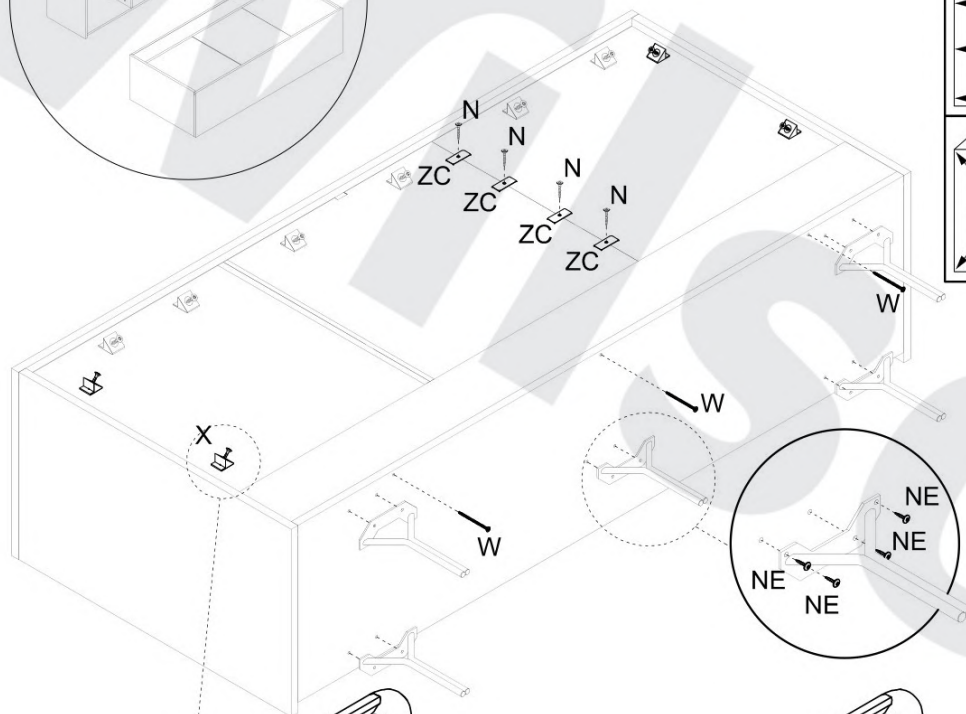
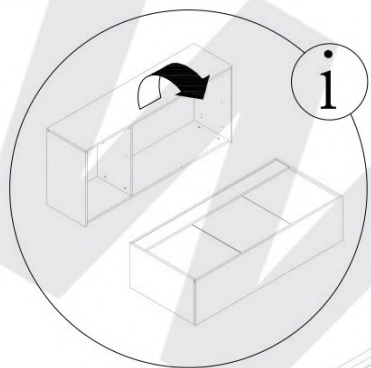
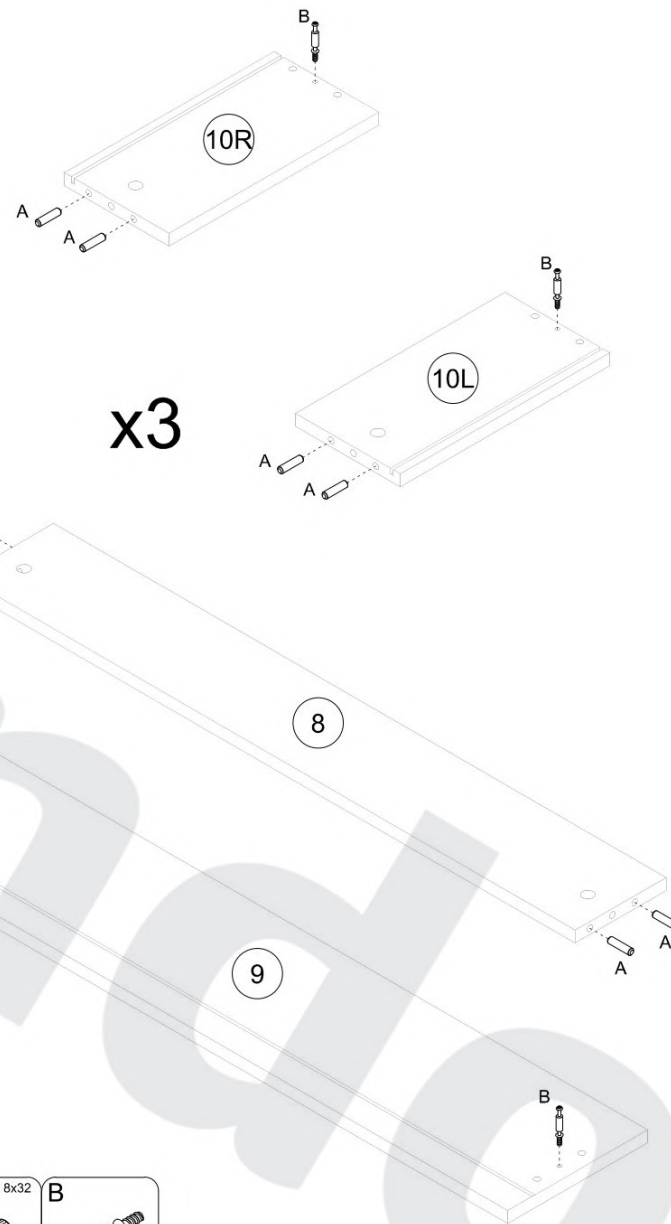

X	ZC	N 3x20	W	NE 4x16	Y	A 8x32	B
x10	x4	x4	x3	x20	x5	x24	x12

12



13

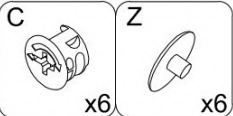
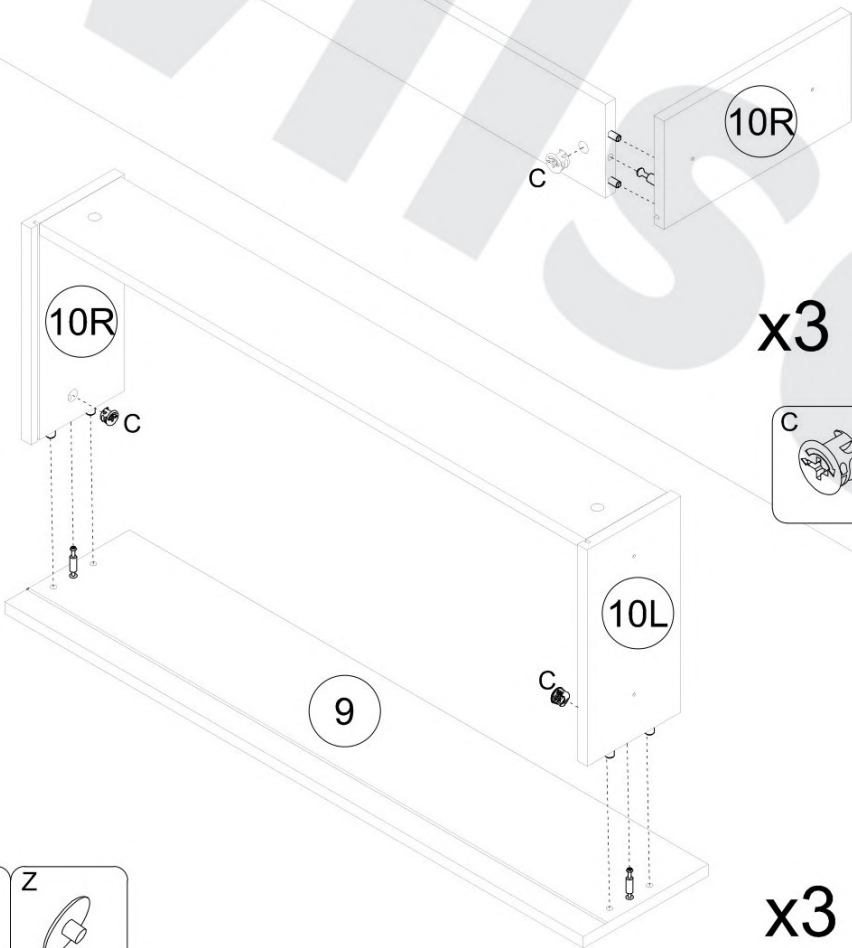

x3

x3

14

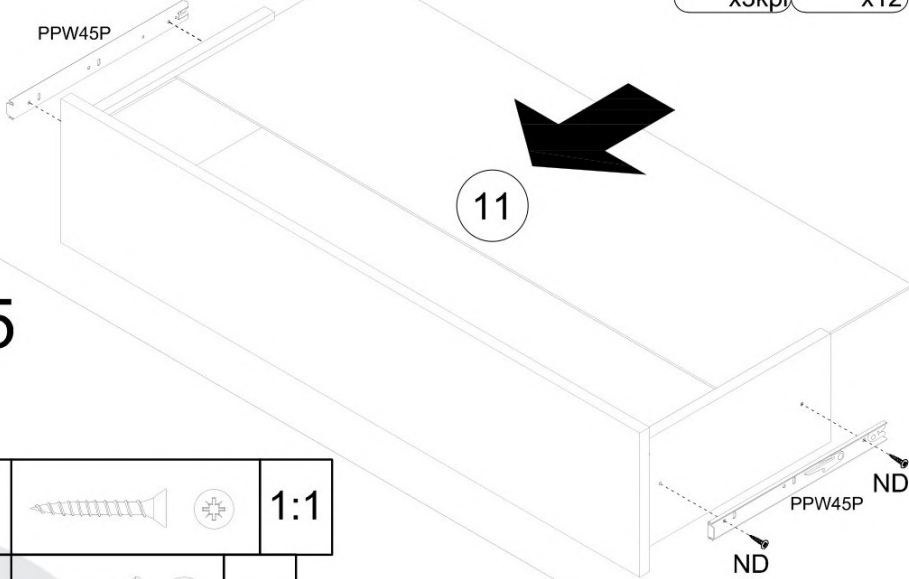

15

N		1:1
ND		1:1

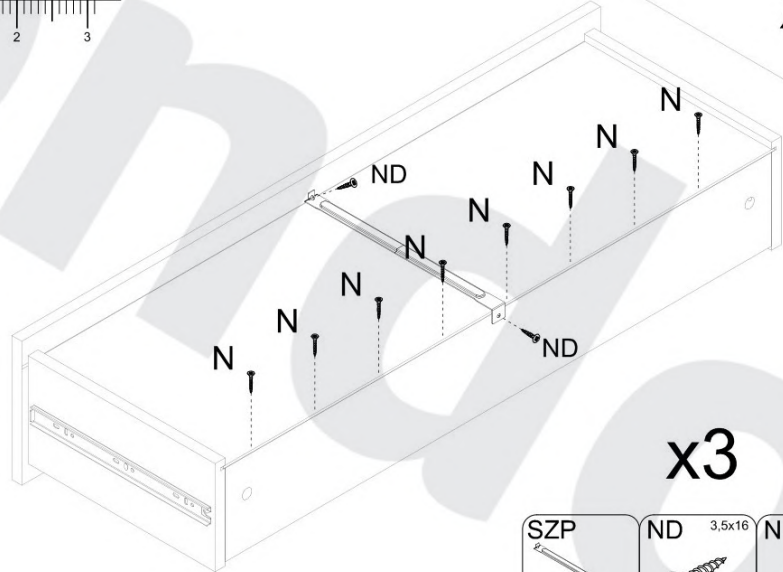

x3

x3

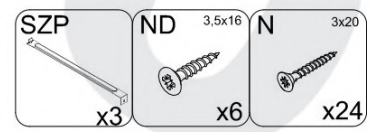

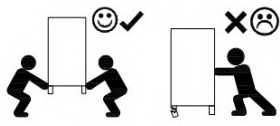
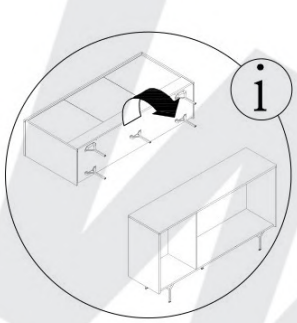

16

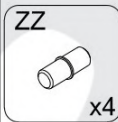
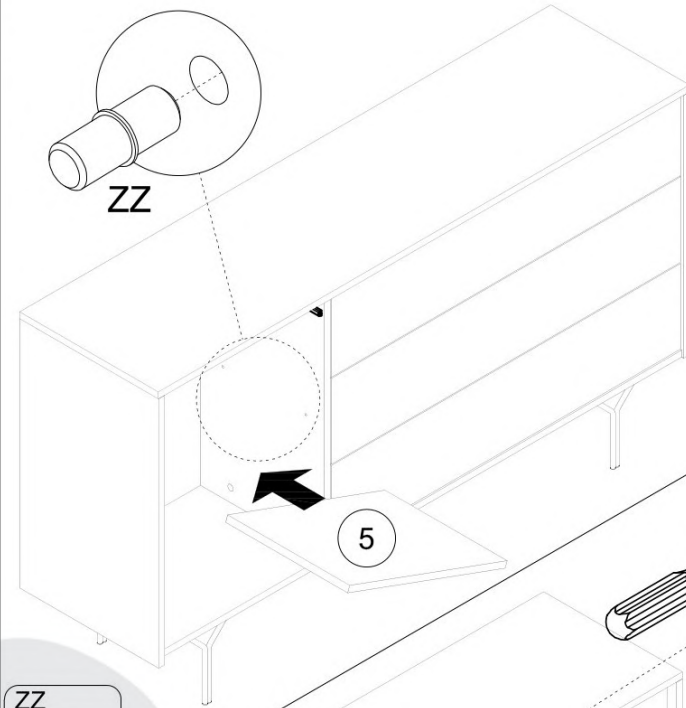
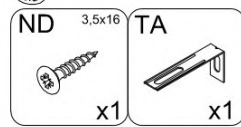
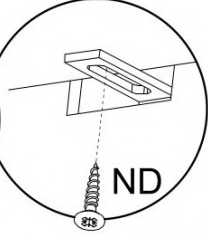
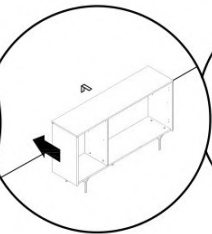
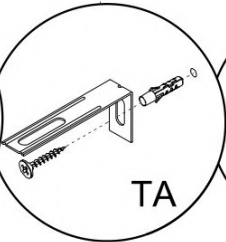
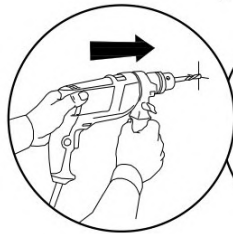
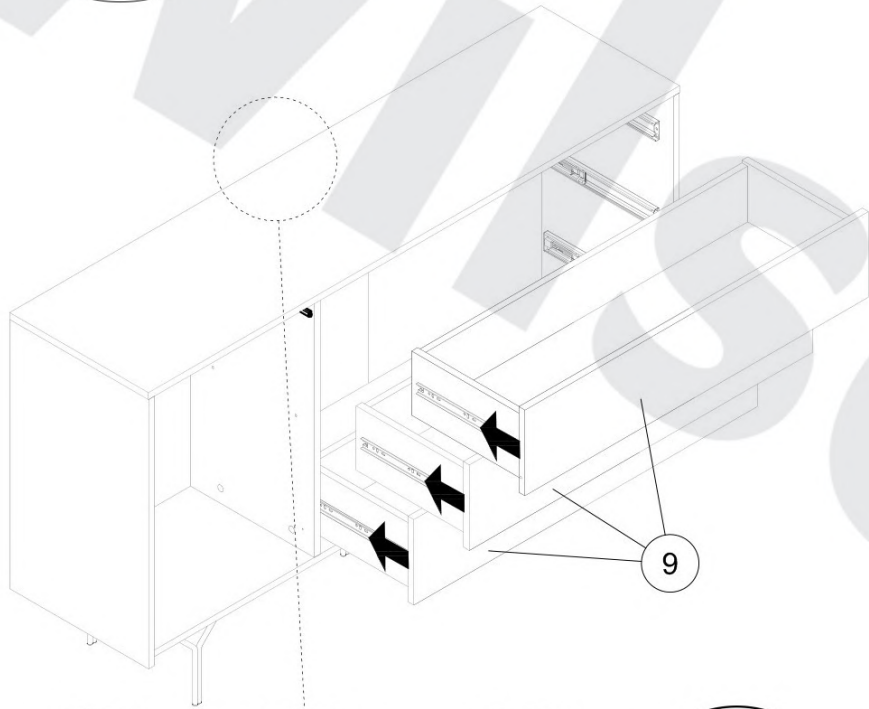

17

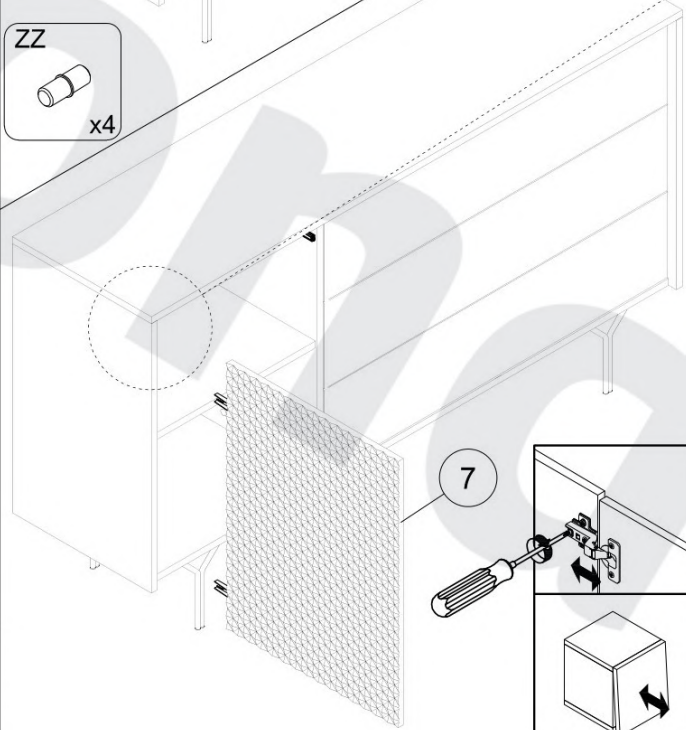

18

