











NICEA 2

A		1	F		18
B		1	G		18
C		3	H		18
D		3			
E		6			

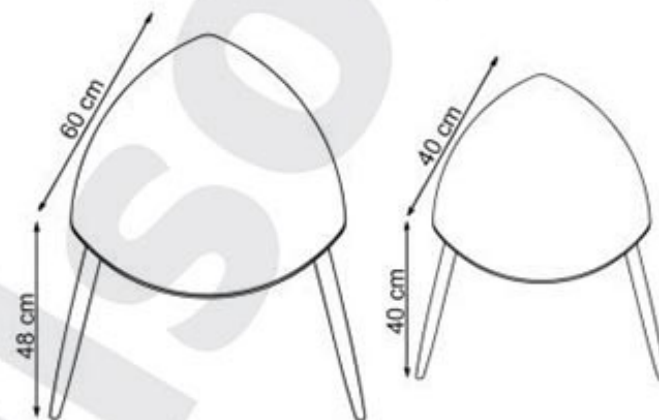
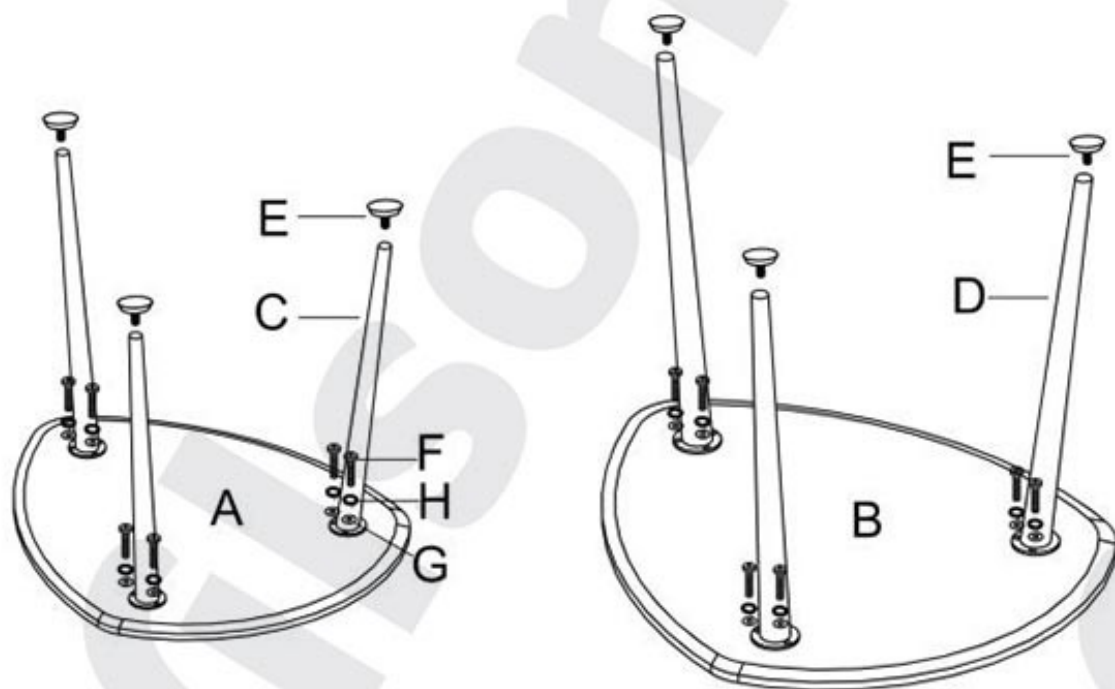

 max. 20 kg

