

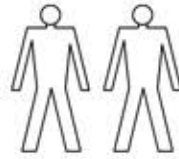

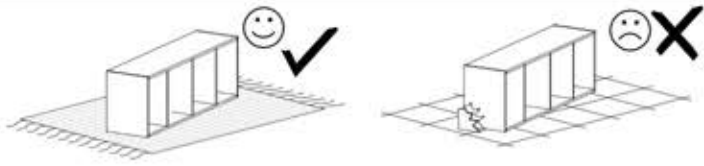





MIRO

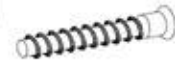

I8  $\varnothing 20$ x8	M11  x1	A1  $\varnothing 7 \times 50$ x8	W2  4mm x1	P7  x4
K1  $\varnothing 15 \times 12$ x8	G4  4x16 x2	K5  x8	W4  x35	B1  $\varnothing 8 \times 35$ x20

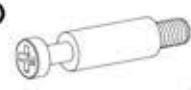
1

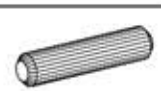
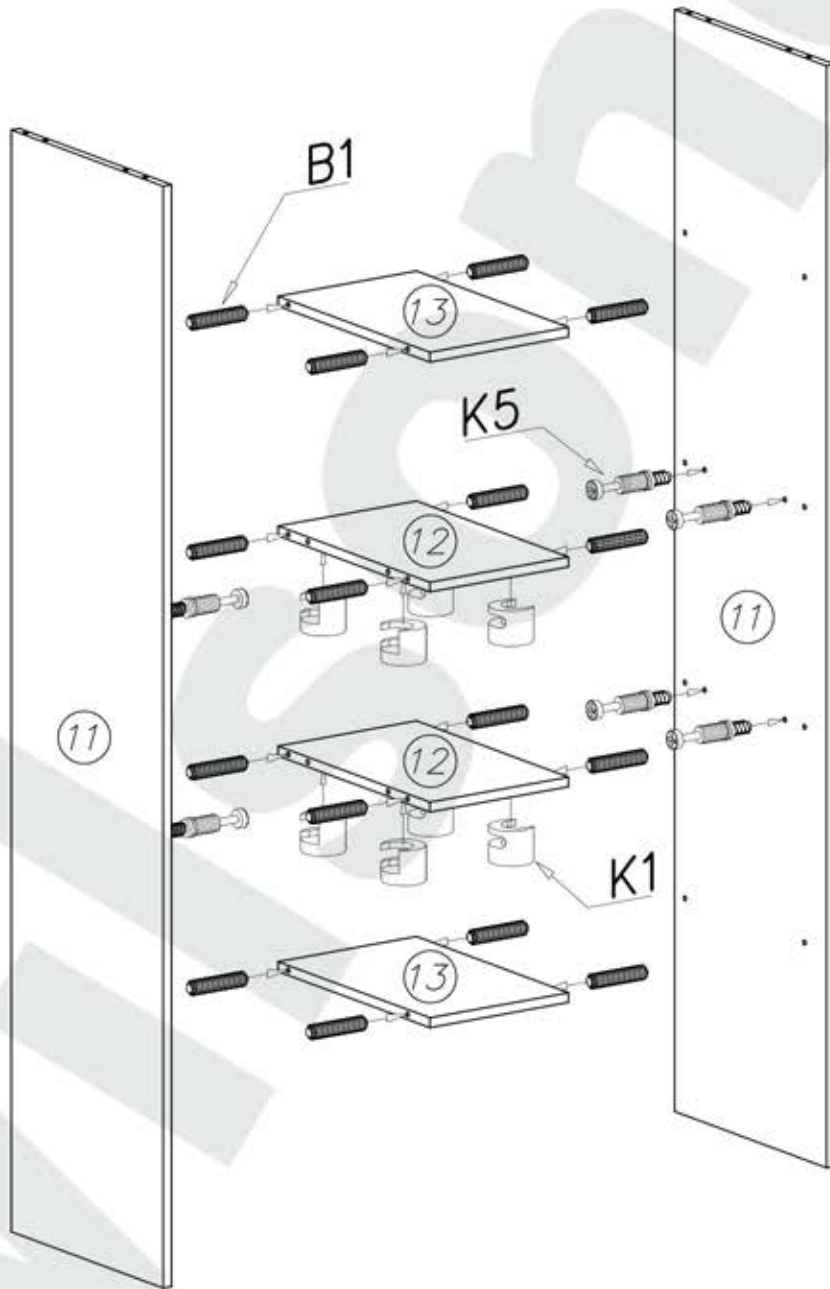
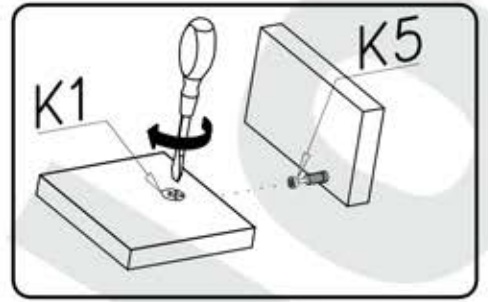
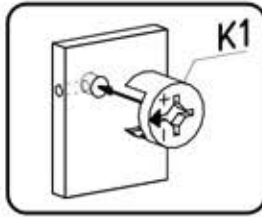
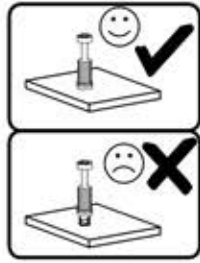
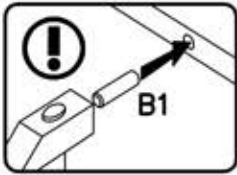

②

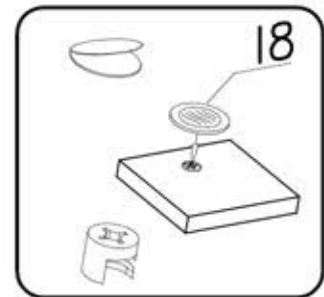
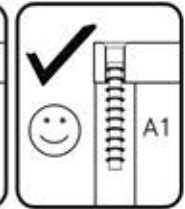
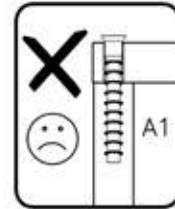
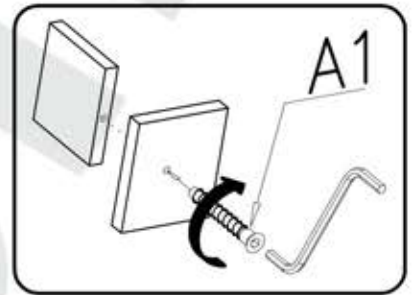
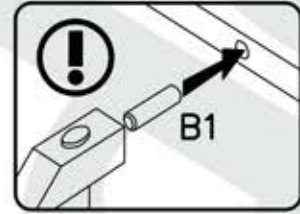
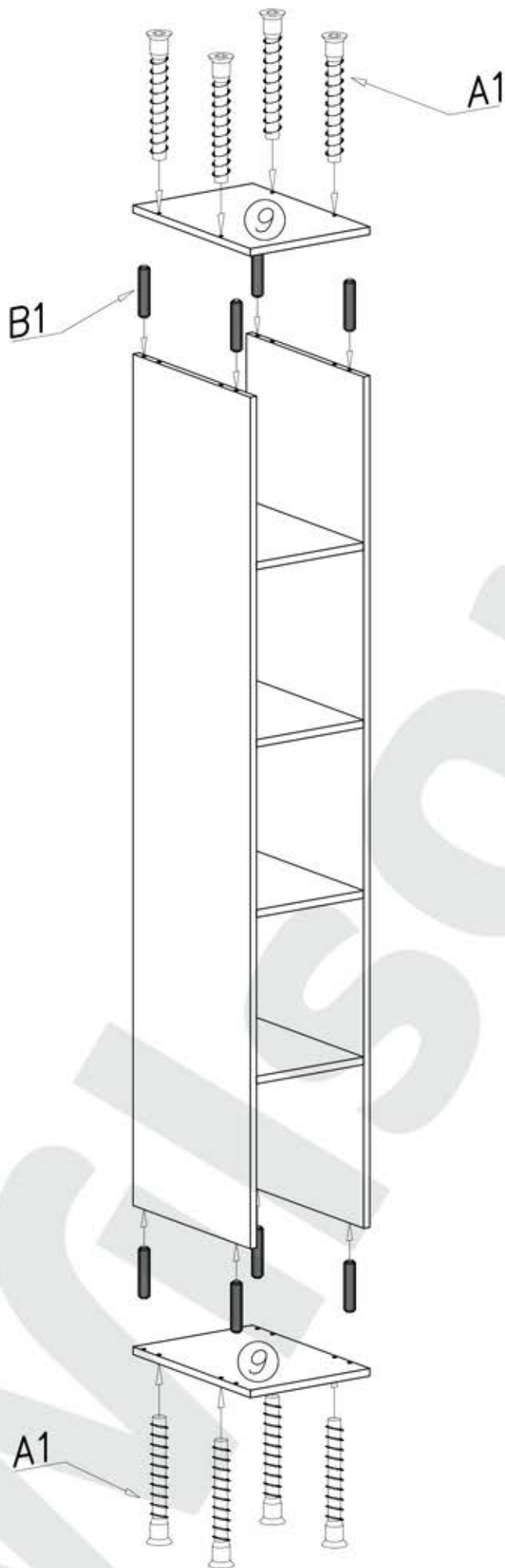

③

$$a = b$$

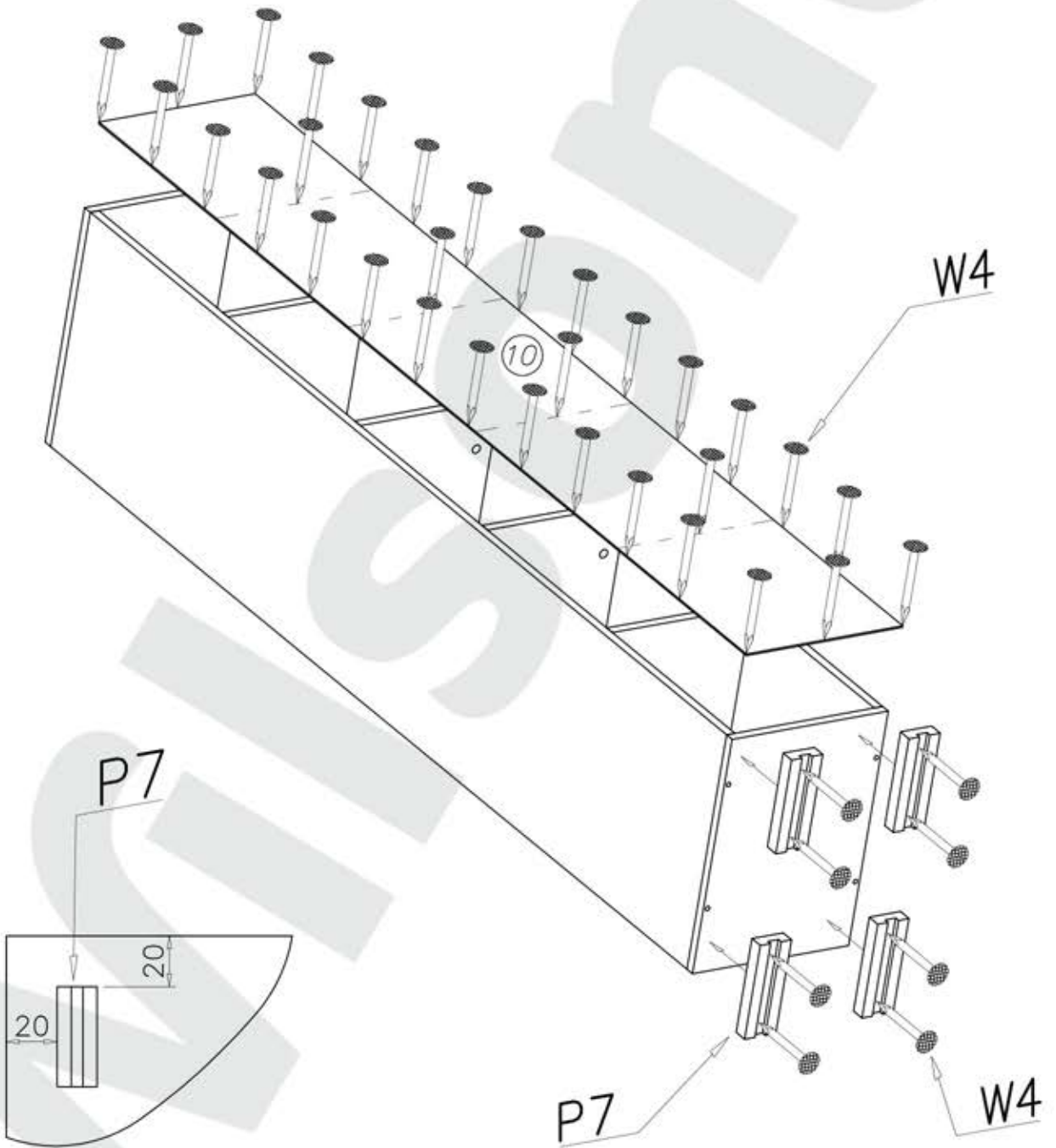
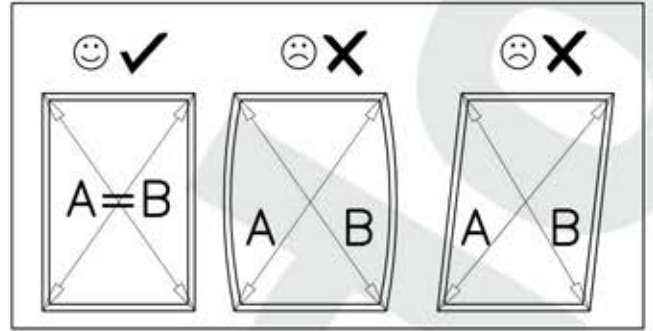
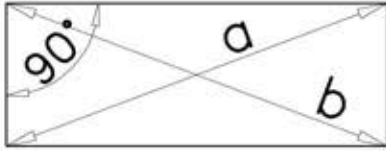

4

