

PL - SZAFKA BIBA 1D / SK - SKRIŇA BIBA 1D / HU - BIBA 1D SZEKREŇY

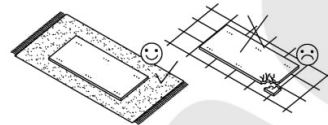

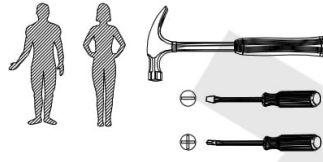

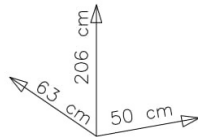

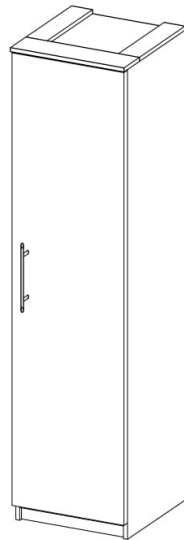
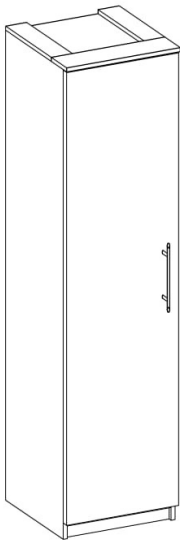

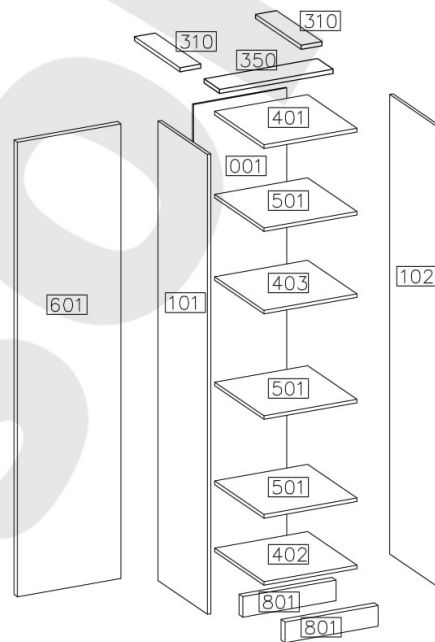





VERSION-L

VERSION-R





#	ART. NR	X
1	401	1
2	402	1
3	403	1
4	501	3
5	101	1
6	102	1
7	601	1
8	801	2
9	001	1
10	350	1
11	310	2

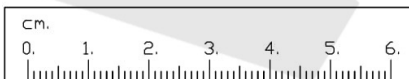

 D1	 $\varnothing 15/12\text{mm}$ C	 E	 $\varnothing 8 \times 30\text{mm}$ A	 H=0 H4	 $\varnothing 35/KR-0$ G6	 $\varnothing 4.0 \times 16\text{mm}$ P1	 L
12	12	12	16	3	3	6	20
 F10	 S1	 R2	 J4	 F1	 J6	 O11	
10	1	6	12	6	2	1	





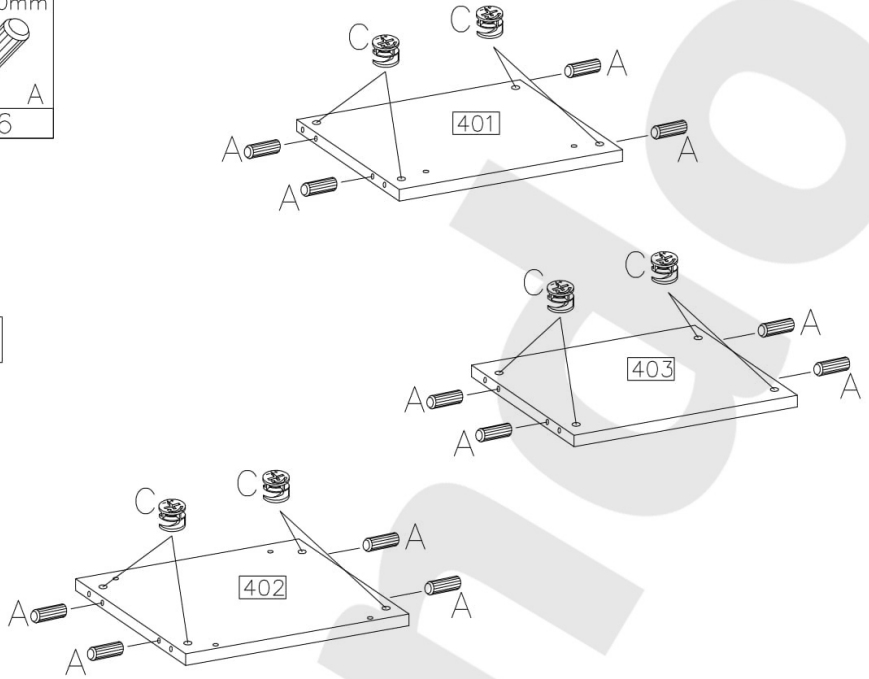
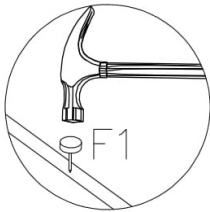
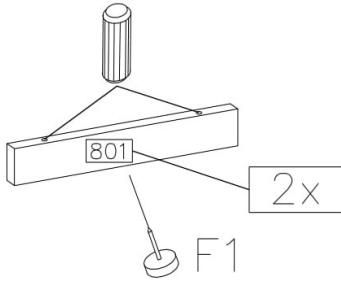

1

		
F1	C	A
2	12	16



2

	
D1	J4
12	12
H=0	
	
H4	F1
3	4

VERSION-R

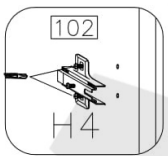

VERSION-L

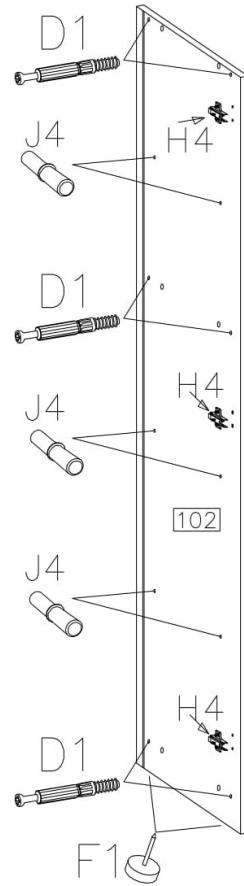
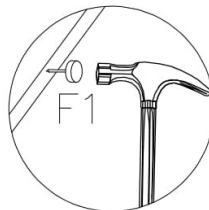
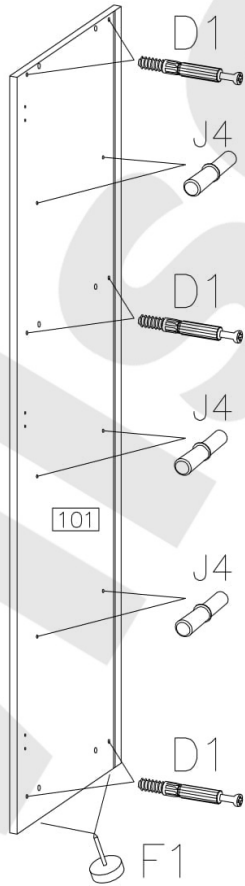
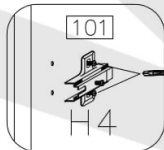

3

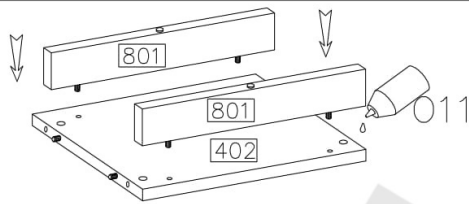
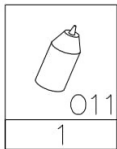

4

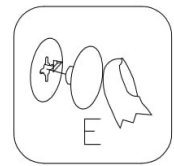
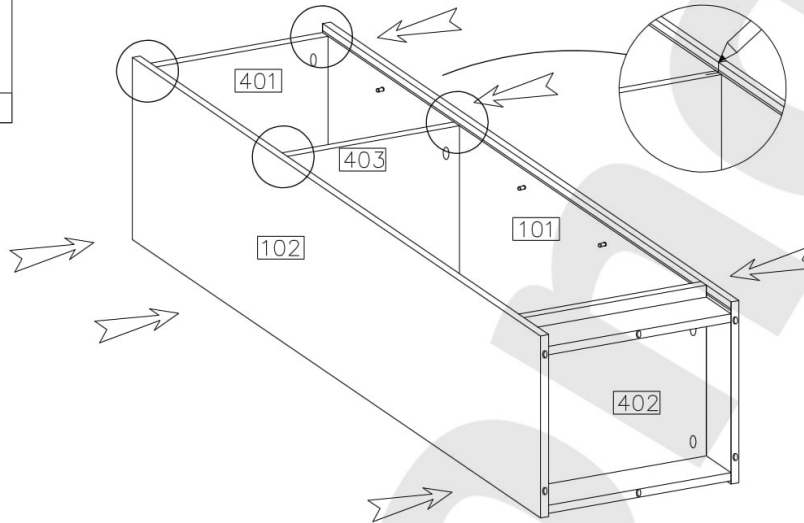
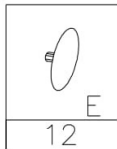

5

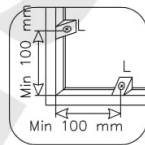
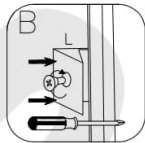
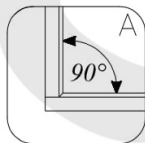
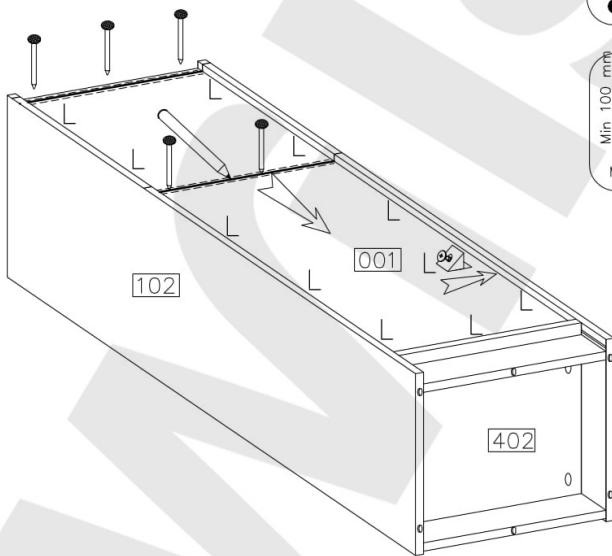
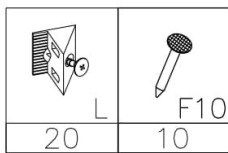

6

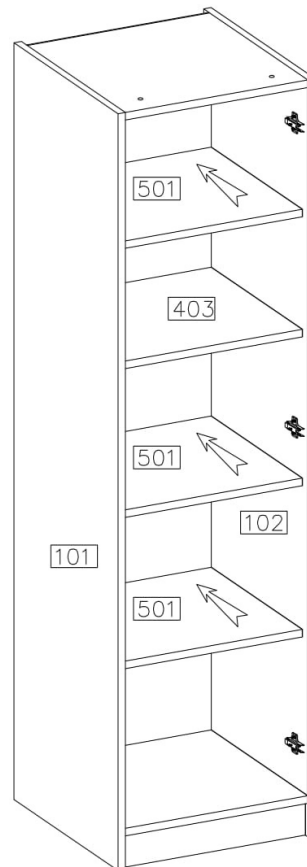

7

- 

ø35/KR-0
G6
- 3
- ø4.0x16mm



P1
- 6
- 

S1
- 1
- 4.0x27mm



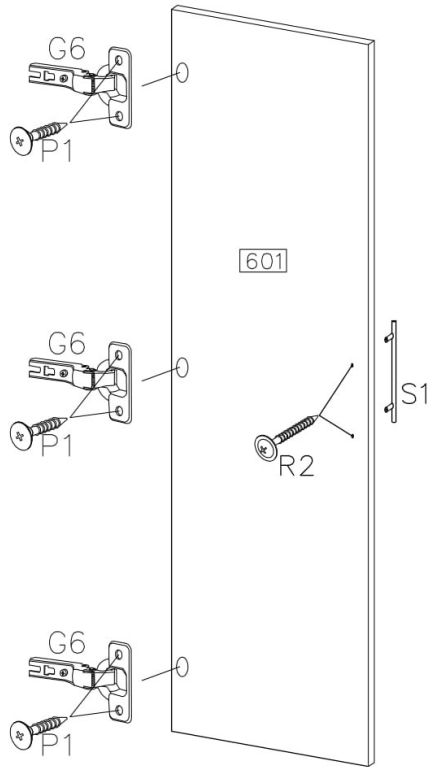

R2
- 2



8

- 4.0x27mm



R2
- 4
- 

J6
- 2

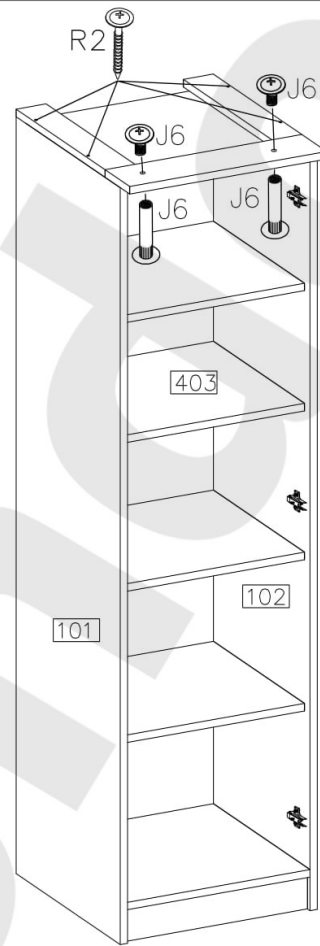

9

VERSION-R

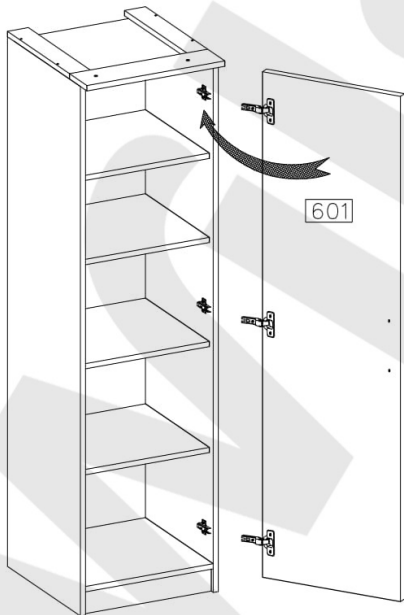

VERSION-L



VERSION-R

