











# AIKIDO

---

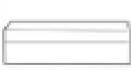
A	B	C	D	E	F	G	H	I	J	K
FI 50 H-40	3,5 cm	M8	M8	8x45	8x60				131 cm	71 cm
										
10	15	2	8	4	2	1	1	2	1	1

**1**

---

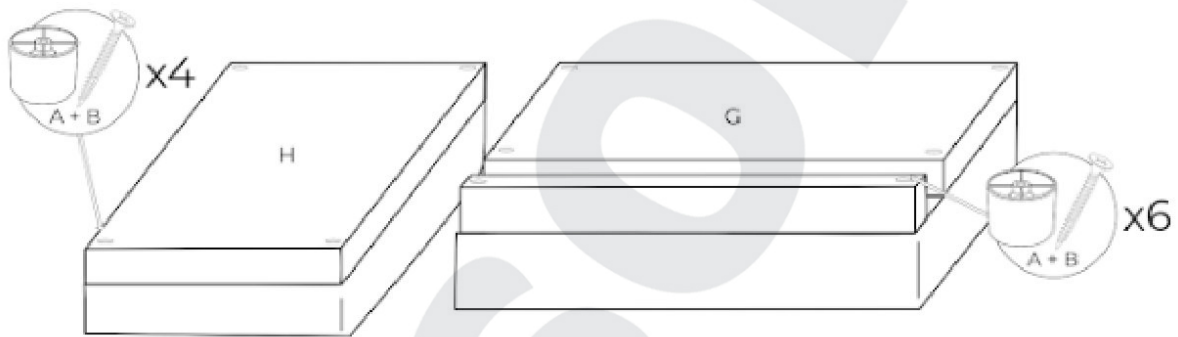

**2**

